



## SPECIFICATION SHEET

### 36" FREESTANDING VANITY CABINET

#### DMV3601



#### VANITY FEATURES

- Designed & Made in Canada
- Premium Select Canadian Maple & Birch Solid Wood and Plywood
- BLUM® European style six-way soft close 110-degree door hinges.
- RICHELIEU® Full Extension concealed soft-close undermount slides.
- Match finished interior cabinet
- Edge-banded drawer with lacquer maple finish
- Handles sold separately and not pre-drilled for design convenience
- 1 Door, 1 Drawer

#### DM BATH 2-YEAR LIMITED WARRANTY

For warranty details visit [www.dmbath.com](http://www.dmbath.com)

#### DOOR STYLE OPTIONS



SLAB PANEL (SL)

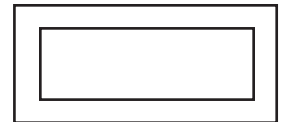

2" SHAKER PANEL (SH)

#### WOOD FINISH OPTIONS

For full colour options visit [www.dmbath.com](http://www.dmbath.com)

#### RELATED PRODUCTS Sold Separately

DMT37	37" Standard Quartz Countertop
DMT37P	37" Premium Quartz Countertop
DMB37	37" Quartz Backsplash
DMB21	21 1/4" Quartz Sidesplash
DCT37	37" Maddox Integral Sink
DMM36	36" Mirror with Solid Wood Frame
MRG26	26 7/16" Frameless Bevel Edge Mirror
FK36	36" Kickplate Set
FS	Filler Strip

#### SPECIFICATION VARIANCE

Our products are constructed to maintain close dimensional tolerances that may vary slightly during the manufacturing of materials; normally +/- 1/8", occasionally more. In most cases, this slight variation does not affect installation, appearance or function. We recommend that you measure the actual cabinet before you frame, design or finish the space for your vanity. We can not be held responsible by the end user if this guideline is not followed. We reserve the right to make revisions without prior notice to product specifications.



**SPECIFICATION SHEET**  
**36" FREESTANDING VANITY CABINET**  
**DMV3601**

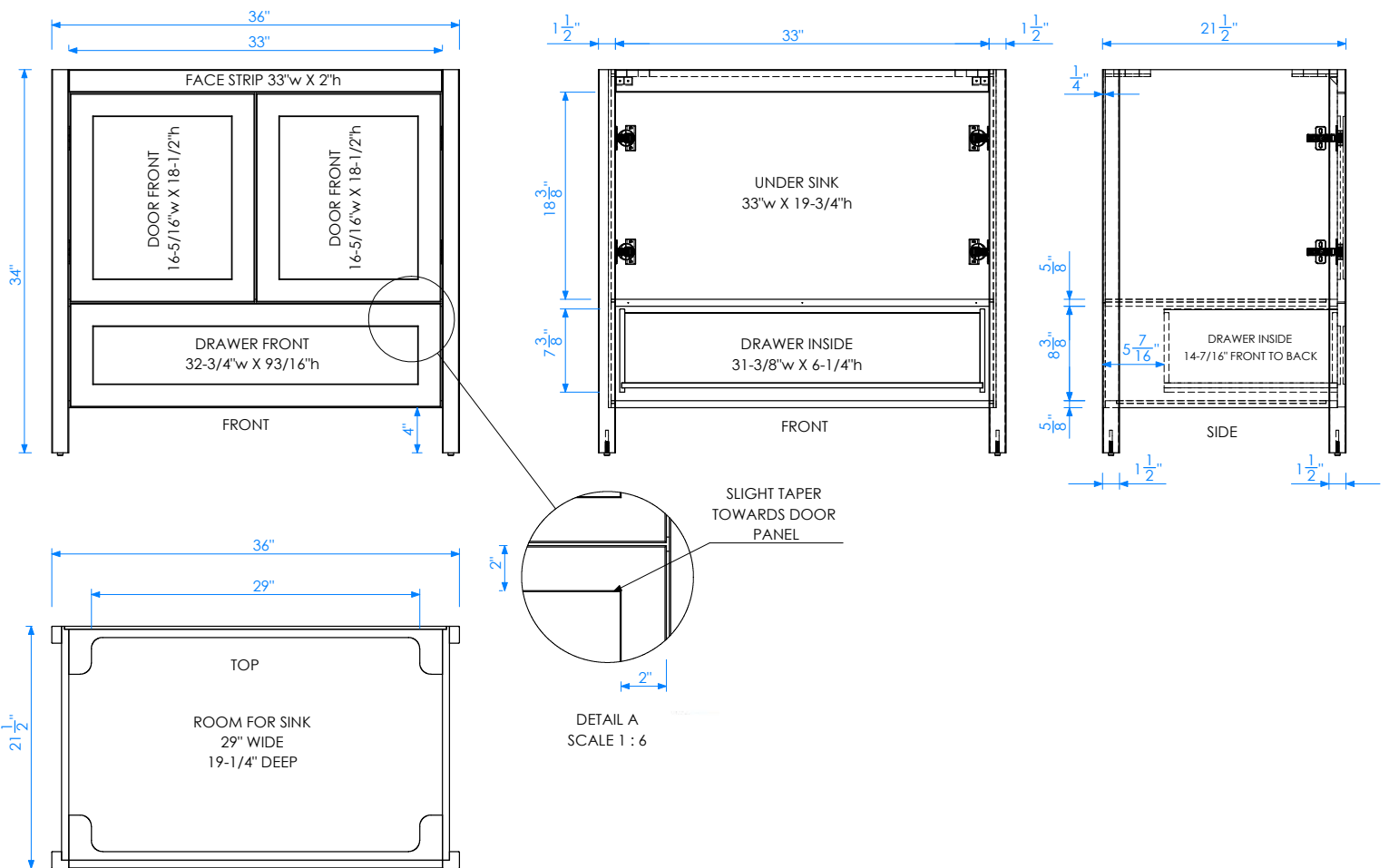

**IMPORTANT NOTE** Please install product according to installation instructions.

**QUICK SPECIFICATION LOOKUP** FREQUENTLY BOUGHT TOGETHER

**37" QUARTZ COUNTERTOP DMT37 STANDARD / DMTP37 PREMIUM**

UNDERMOUNT SINK CUT  
INCLUDES 18" OXFORD UNDERMOUNT SINK (DMS01W)

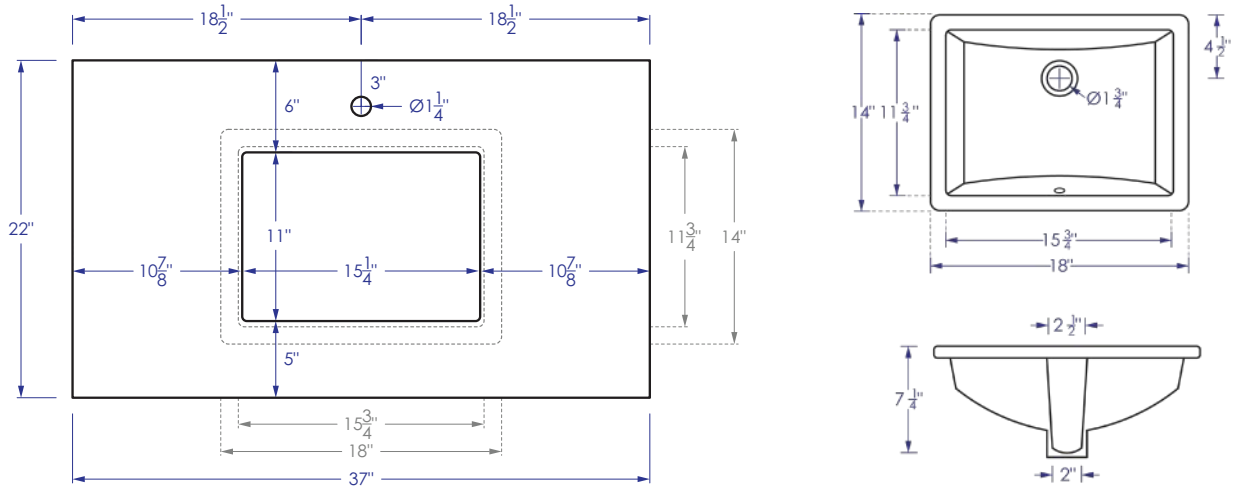

VESSEL SINK CUT  
NO DRILL HOLE OR VESSEL SINK CUT INCLUDED

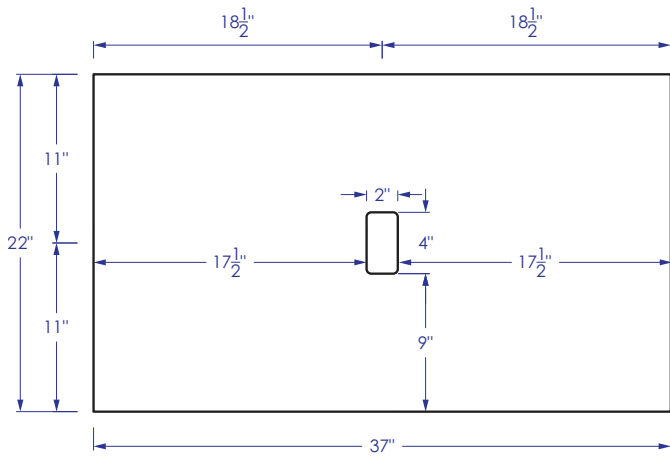

SIDE PROFILE VIEW

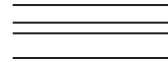

**0.75" STANDARD; EASED EDGE PROFILE**  
**1.5" PREMIUM; CHOICE OF EDGE PROFILE**

For Premium Edge Profile Options visit [www.dmbath.com](http://www.dmbath.com).

**37" QUARTZ BACKSPLASH DMB37**



**21.25" QUARTZ SIDESPLASH DMB21**

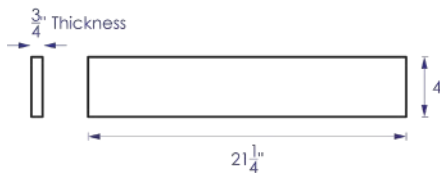

**QUICK SPECIFICATION LOOKUP** FREQUENTLY BOUGHT TOGETHER

**36" KICKPLATE SET FK36**

Kickplate Set includes one front panel (B) and two side panels (A). Used to fill the gap between the floor and vanity, installed recessed to enable your feet to rest comfortably and allow you to get closer to the countertop.

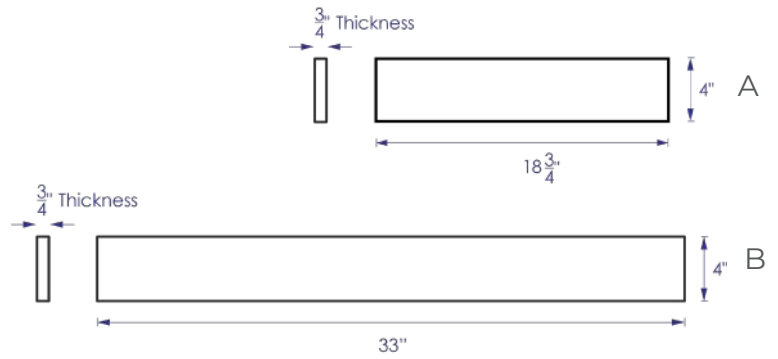
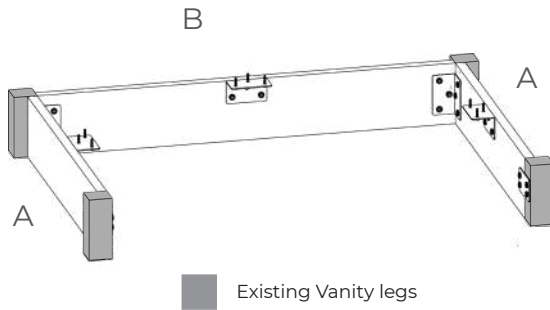

**FILLER STRIP FS**

Filler Strip fills the gap between the side of your vanity cabinet and the wall. Fillers are normally cut to your required size by your professional installer.

